



产 品 承 认 书

| | | | |
|--------|--|---------|------------------|
| 客户名称 | | 供应商产品名称 | 2835 0.5W 白光系列 |
| 客户物料编号 | | 供应商产品料号 | MCWXXXXXXXX-冷白光 |
| | | | MPWXXXXXXXX-正白光 |
| | | | MNWXXXXXXXX-自然白 |
| | | | MWWXXXXXXXX-暖白光 |
| | | | MWAXXXXXXXXX-白转黄 |
| 产品规格 | | 版本号 | A0 |

| 供应商确认 | | | |
|-------|----|-----|-----------|
| 拟定 | 审核 | 批准 | 日期 |
| 胡德美 | 文思 | 罗泽永 | 2023-7-21 |

| 客户确认 | | | |
|------|----|----|----|
| 采购 | 工程 | 品管 | 日期 |
| | | | |

深圳市光明新区公明镇楼村世峰科技园 F 栋 5 楼

Tel. : 86-755-29694811

Fax: 86-755-29536086

Http: //www.tengjie-led.com, http://www.led818.com

E-mail: led@tengjie-led.com

■ Applications

Interior automotive lighting (dashboard backlight etc...)

Optical indicators

Communication Products

Backlighting

Flash

Toy

■ Package Dimensions

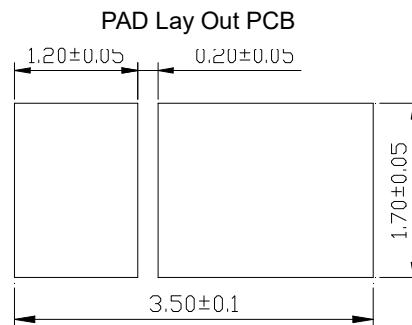
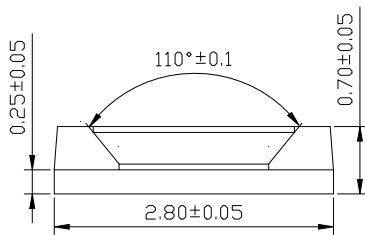
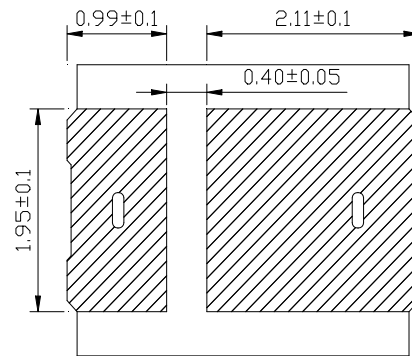
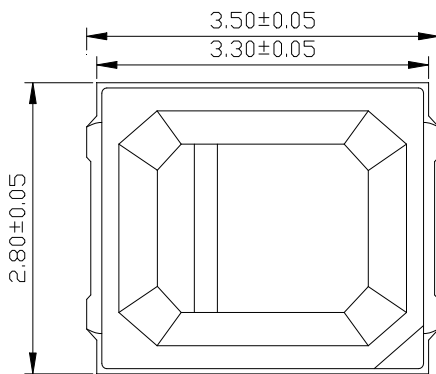

Notes:

1. All dimensions are in millimeters.
2. Tolerance is $\pm 0.20\text{mm}$ unless otherwise noted.
3. Protruded resin under flange is 1.0mm max
4. Lead spacing is measured where the leads emerge from the package.
5. Caution in ESD:

Static Electricity and surge damages the LED. It is recommending to use a wrist band or anti-electrostatic glove when handling the LED. All devices, equipment and machinery must be properly grounded.

■ Absolute Maximum Ratings (Ta = 25°C)

| Parameter | Symbol | Colour | Value | Unit |
|--|---------------------|---|-----------|------|
| Power Dissipation | Pd | Cool White/White/Naturally White/Warm White | 0.5 | W |
| Peak pulsing current (1/8 duty f=1KHz) | Ifp | Cool White/White/Naturally White/Warm White | 200 | mA |
| Forward Current | If | Cool White/White/Naturally White/Warm White | 150 | mA |
| Operating Temperature Range | Top | Cool White/White/Naturally White/Warm White | -25~+80 | °C |
| Storage Temperature Range | Tstg | Cool White/White/Naturally White/Warm White | -30~+85 | °C |
| Junction Temperature | Tj | Cool White/White/Naturally White/Warm White | 115 | °C |
| Electrostatic Discharge | ESD | Cool White/White/Naturally White/Warm White | 2000(HBM) | V |
| Lead Soldering Temperature | 260°C for 3 Seconds | | | |

■ Typical Electrical & Optical Characteristics (Ta = 25°C)

| Parameter | Colour | Symbol | Min. | Typ. | Max. | Unit | Test Condition |
|-----------------------|----------------|--------|------|------|------|------|----------------|
| Forward Voltage | CW/PW/NW/WW/MA | VF | 2.8 | -- | 3.4 | V | IF=150mA |
| Color Rendering Index | CW/PW/NW/WW/MA | CRI | -- | -- | -- | Ra | IF=150mA |
| Viewing Angle | CW/PW/NW/WW/MA | 2θ1/2 | -- | 120 | -- | Deg | IF=150mA |
| Reverse Current | CW/PW/NW/WW/MA | Ir | -- | -- | 10 | μA | Vr=5V |

■ Color temperature Guide (Ta = 25°C)

| Colour | Temperature | Min. | Typ. | Max. | Unit | Test Condition |
|-----------------|-------------|------|------|--------|------|----------------|
| Cool White | CCT | 7000 | -- | 250000 | K | IF=150mA |
| White | CCT | 6000 | -- | 7000 | K | IF=150mA |
| Naturally White | CCT | 3700 | -- | 4500 | K | IF=150mA |
| Warm White-暖白光 | CCT | 2000 | -- | 3400 | K | IF=150mA |
| Warm White-白转黄 | CCT | 1600 | -- | 2000 | K | IF=150mA |

■ Luminous Intensity/Light Intensity Guide(Ta = 25°C)

| Colour | Symbol | Min. | Typ. | Max. | Unit | Test Condition |
|-----------------|--------|------|------|------|------|----------------|
| Cool White | Φv | 50 | -- | 65 | LM | IF=150mA |
| White | Φv | 60 | -- | 75 | LM | IF=150mA |
| Naturally White | Φv | 60 | -- | 75 | LM | IF=150mA |
| Warm White-暖白光 | Φv | 50 | -- | 65 | LM | IF=150mA |
| Warm White-白转黄 | Φv | 45 | -- | 60 | LM | IF=150mA |

■ Notes:

- Luminous intensity is measured with a light sensor and filter combination that approximates the CIE eye-response curve.
- $\theta_{1/2}$ is the off-axis angle at which the luminous intensity is half the axial luminous intensity.
- It use many parameters that correspond to the CIE 1931 2°. X, Y, and Z are CIE 1931 2° values of Red, Green and Blue content of the measurement.

■ Chromatic Coordinates Ranks(ERP):

| CCT | center | | 6step a | 6step b | ∅ | step |
|------|--------|--------|------------|------------|-------|------|
| | x | y | | | | |
| 9398 | 0.2842 | 0.2926 | 0.00195 | 0.00091 | 62.36 | 6 |
| 7420 | 0.3012 | 0.3113 | 0.00209 | 0.00093 | 61.78 | 6 |
| 6430 | 0.3130 | 0.3370 | 0.00221 | 0.00095 | 58.57 | 6 |
| 5000 | 0.3460 | 0.3590 | 0.00274 | 0.00119 | 59.62 | 6 |
| 4040 | 0.3800 | 0.3800 | 0.00313 | 0.00134 | 53.71 | 6 |
| 3450 | 0.4090 | 0.3940 | 0.00309 | 0.00138 | 54.00 | 6 |
| 2940 | 0.4400 | 0.4030 | 0.00278 | 0.00137 | 53.21 | 6 |
| 2720 | 0.4630 | 0.4200 | 0.00258 | 0.00134 | 57.27 | 6 |

■ Chromaticity Coordinate Groups(ANSI):

| CCT | center | | 6step a | 6step b | ∅ | step |
|------|--------|--------|------------|------------|-------|------|
| | x | y | | | | |
| 9543 | 0.2833 | 0.2915 | 0.00195 | 0.00090 | 62.36 | 6 |
| 7534 | 0.3000 | 0.3099 | 0.00208 | 0.00092 | 61.81 | 6 |
| 6530 | 0.3123 | 0.3282 | 0.00223 | 0.00095 | 58.57 | 6 |
| 5665 | 0.3287 | 0.3417 | 0.00249 | 0.00107 | 59.09 | 6 |
| 5028 | 0.3447 | 0.3553 | 0.00274 | 0.00119 | 59.62 | 6 |
| 3985 | 0.3818 | 0.3797 | 0.00313 | 0.00134 | 53.71 | 6 |
| 3465 | 0.4073 | 0.3917 | 0.00309 | 0.00138 | 54.00 | 6 |
| 3045 | 0.4338 | 0.4030 | 0.00278 | 0.00137 | 53.21 | 6 |

■ Chromaticity Coordinate Groups:

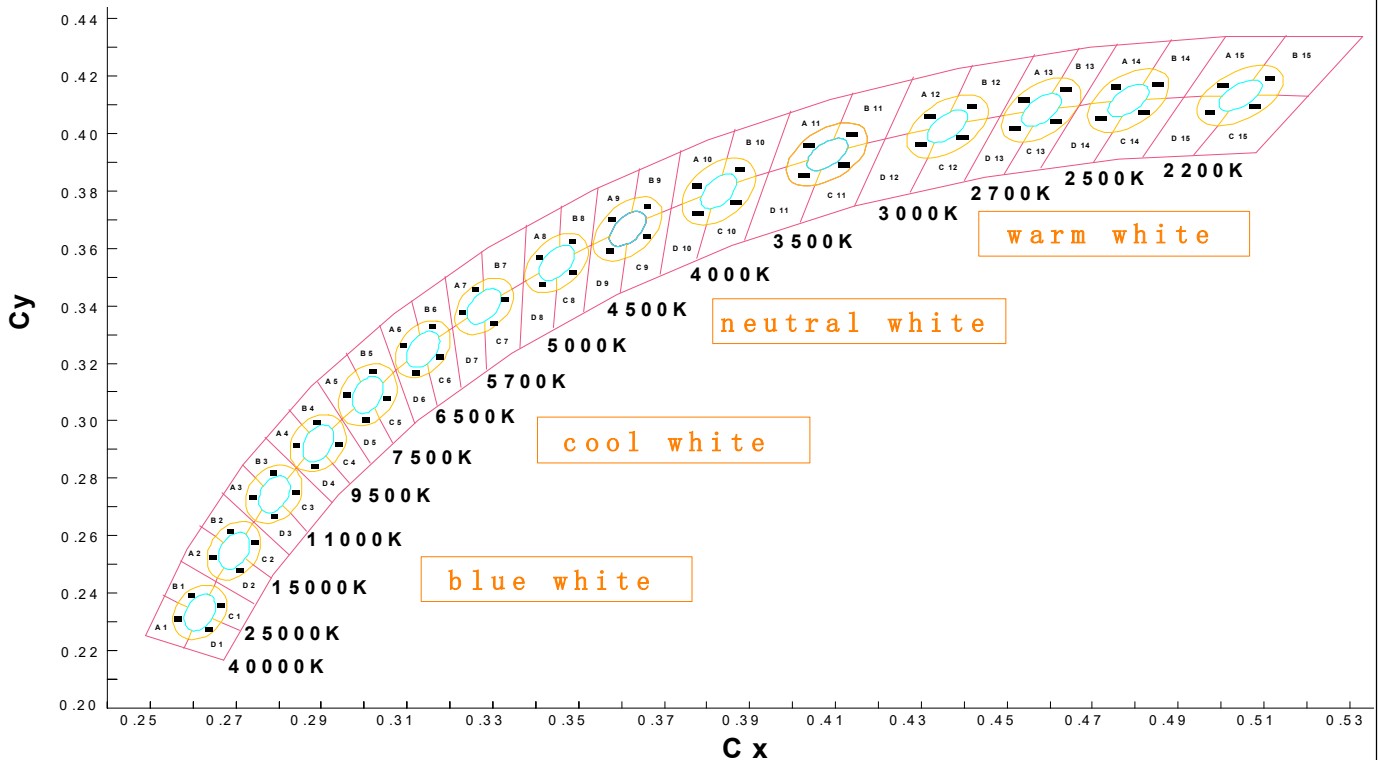

■ Typical Electrical/ Optical Characteristics Curves

(Ta=25°C Unless Otherwise Noted)

Forward Voltage VS. Forward Current (Ta=25°C)

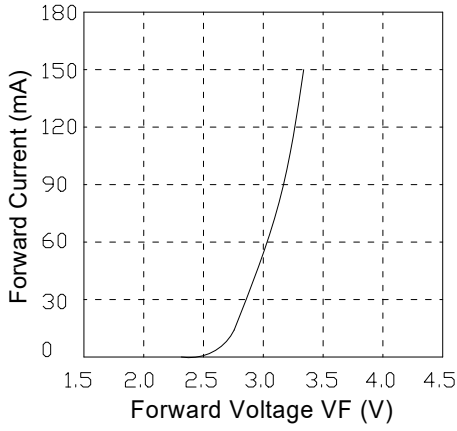

Relative Intensity VS. Forward Current (Ta=25°C)

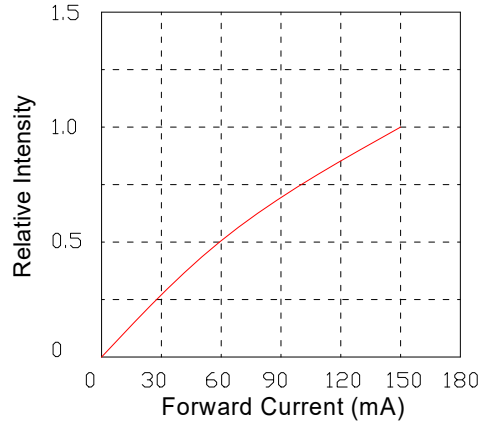

Relative Intensity VS. Ambient Temperature

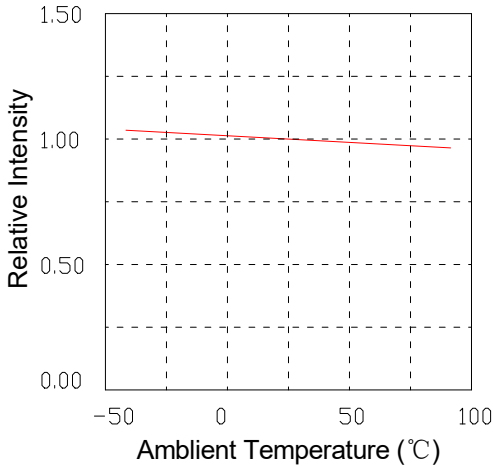

Spectral Distribution

Relative Intensity VS. Wavelength (Ta=25°C)

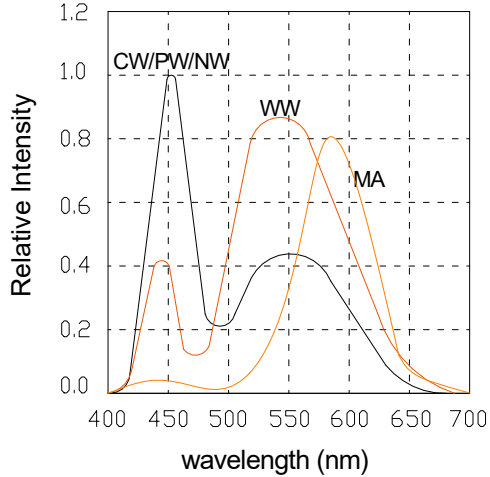

Derating

Ambient Temperature VS. Maximum Forward Current

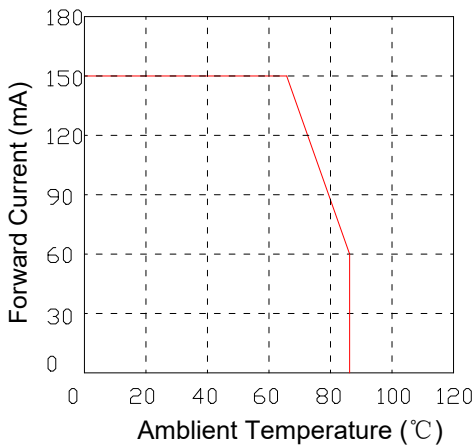
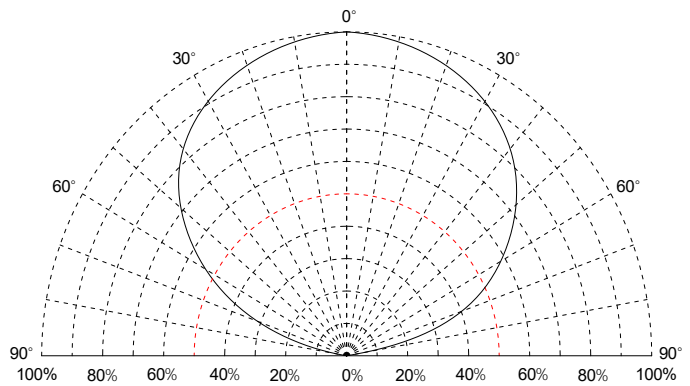

Diagram characteristics of radiation



Note: The data shown above are typical curves. Every LED component may have some variations of characteristics.

■ Test Items and Conditions:

| No. | Test Item 测试项目 | TJ. Standard 腾杰参照标准 | Test Conditions 测试条件 | Note 频次 | Number of Damaged 允许破坏数 |
|-----|--|--------------------------|--|------------|----------------------------|
| 01 | Temperature Cycle 高低温循环 | JIS C 7021 (1977)A-4 | -25°C 30min ↑↓5min 80°C 30min | 100 cycle | 0/22 |
| 02 | Thermal Shock 冷热冲击测试 | MIL-SLD-107D | -25°C 15min ↑↓5min 80°C 15min | 50 cycle | 0/22 |
| 03 | High Humidity Heat Cycle 高湿度热循环 | JIS C 7021 (1977)A-5 | 30°C (<=>) 65°C 90%RH 24hrs/1cycle | 10 cycle | 0/22 |
| 04 | High Temperature Storage 高温存储 | JIS C 7021 (1977)B-10 | T _a =85°C | 1000 hrs | 0/22 |
| 05 | Humidity Heat Storage 高温高湿存储 | JIS C 7021 (1977)B-11 | T _a =60°C RH=90% | 1000 hrs | 0/22 |
| 06 | Low Temperature Storage 低温贮藏 | JIS C 7021 (1977)B-12 | T _a =-30°C | 1000 hrs | 0/22 |
| 07 | Life Test 常温寿命测试 | JIS C 7035 (1985) | T _a =25°C I _F =150mA | 1000 hrs | 0/22 |
| 08 | High Humidity Heat Life Test 高温高湿寿命测试 | ① | 60°C RH=90% I _F =150mA | 500 hrs | 0/22 |
| 09 | Low Temperature Life Test 低温寿命测试 | ① | T _a =-25°C I _F =150mA | 1000 hrs | 0/22 |

① Refer to reliability test standard specification for in this line. 请参考可靠性测试标准规范

■ Criteria For Judging Damage:

| No. | Test Item 测试项目 | Symbol 符号 | Test Conditions 测试条件 | Decision criteria 判定标准 |
|-----|---|----------------|---------------------------------|---|
| 01 | 正向电压 Forward Voltage | V _F | I _F =I _{FT} | 初始值±10% Initial Data±10% |
| 02 | 反向电流 Reverse Current | I _R | V _R =5V | I _R ≤ 10μA |
| 03 | 光强 Luminous Intensity | I _V | I _F =I _{FT} | 平均 I _V 衰减 ≤ 30%，单个平均 I _V 衰减 ≤ 50% Average I _V degradation ≤ 30% Single LED I _V degradation ≤ 50% |
| 04 | 耐焊接热 Resistance to Soldering Heat | -- | -- | 材料无内部裂痕、无材料间爆裂、剥离、无死灯 Material without internal cracks, no material between stripped, no deaded light. |

*The technical information shown in the data sheets are limited to the typical characteristics and circuit examples of the referenced products. It does not constitute the warranting of industrial property nor the granting of any license.

数据工作表中所示的技术信息仅限于典型特征和电路实例引用的产品,它既不构成工业特性的保证,也不构成任何许可的授权

■ Soldering heat reliability:
Lead Solder

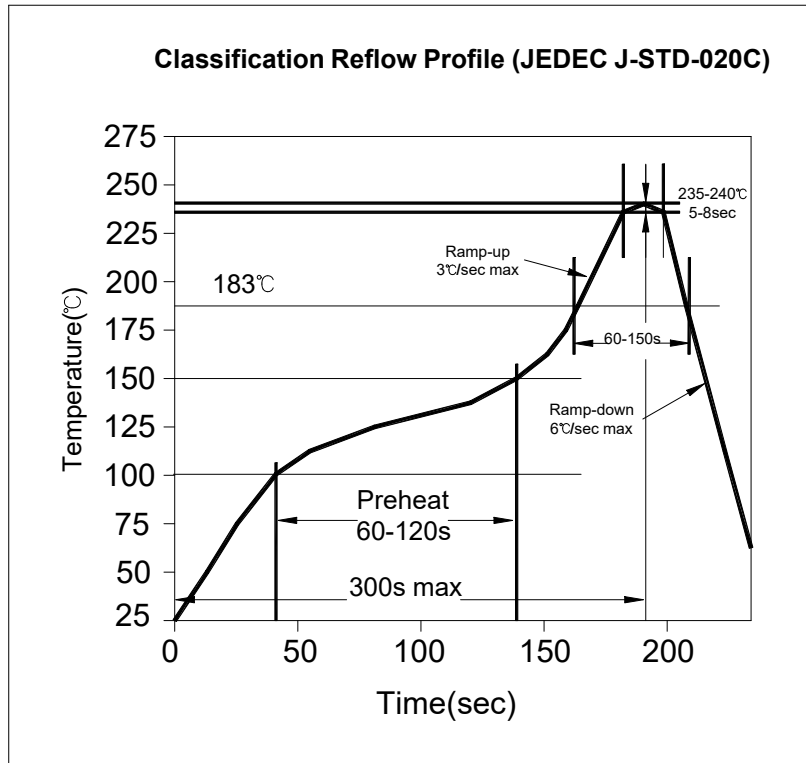

Lead-Free Solder

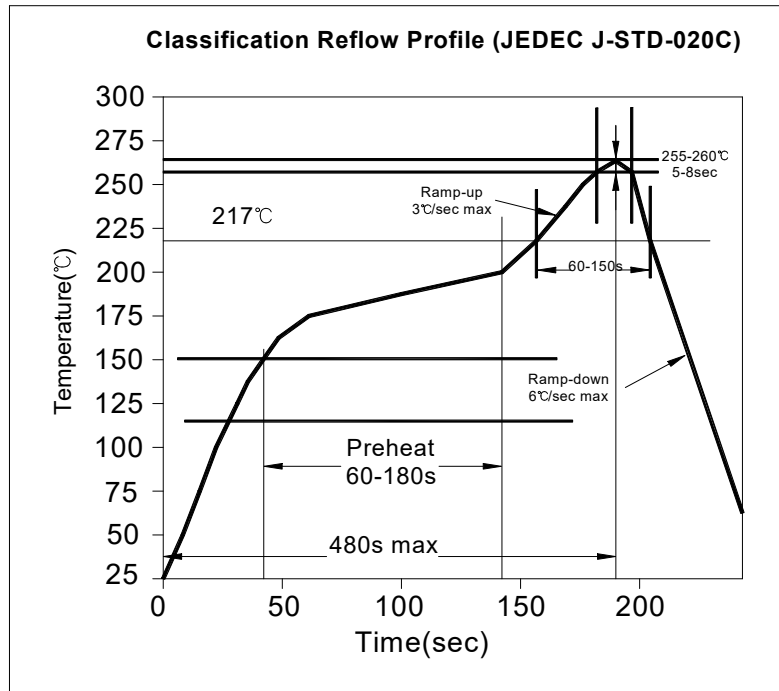

■ Packing Specifications:

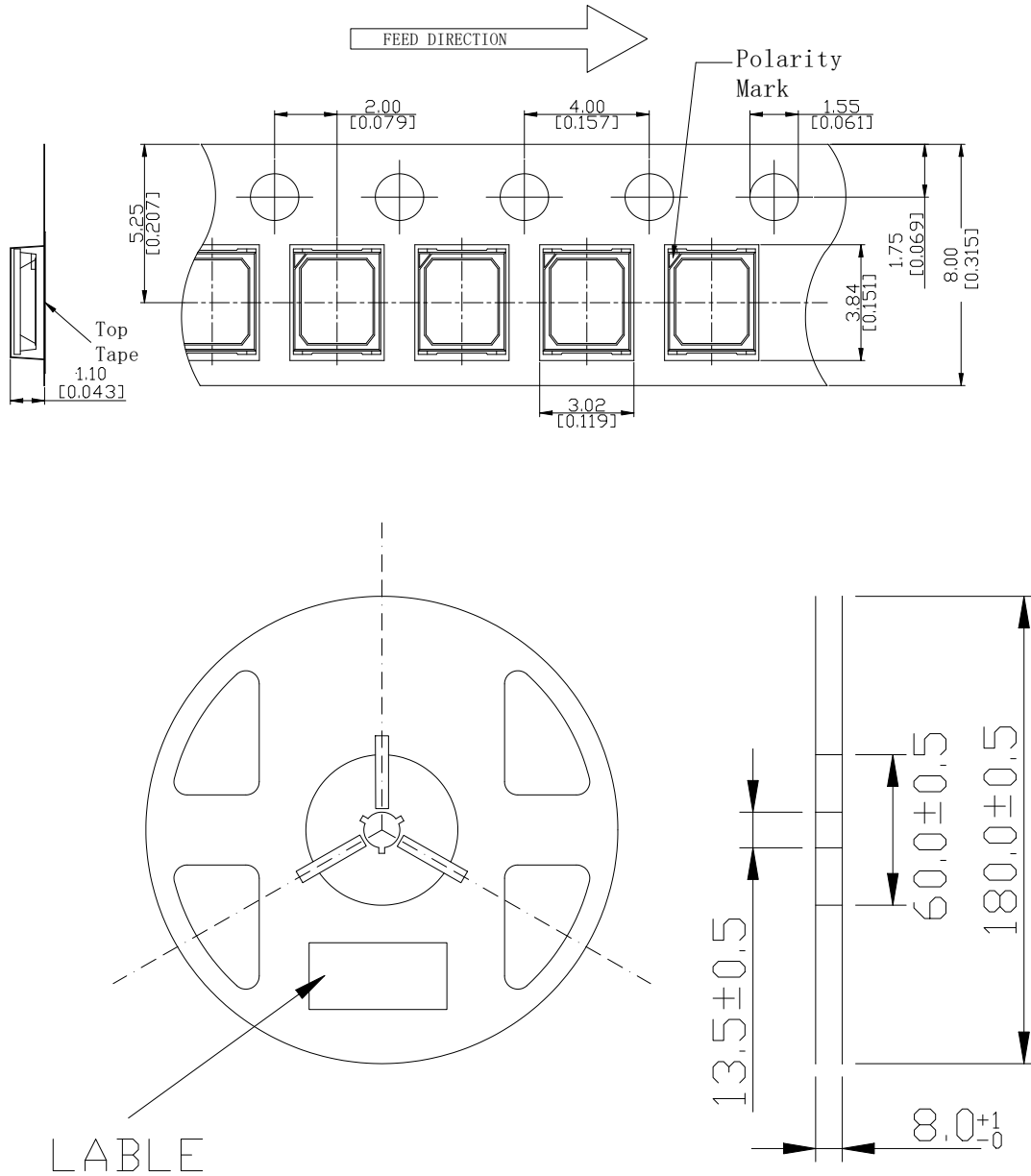

Notes:

- 1) The packing only appropriate for TJ.
- 2) Normal packing quantity: 4,000pcs/reel.

■ **Precaution of Application** 应用预防措施

1: Circuit layout

Due to the forward voltage of LED will vary with temperature and its driving current, the current- limited protective circuit should be considered in the LED circuit design.

When LEDs are arrayed as parallel circuit, different inherent resistance of LED will cause unbalance current. The unbalanced driving current which exists in every parallel circuit may make LED to be driven at different power. Therefore, the LED driven at higher power may be damaged by over driving current, and the LED driven at lower power may be dimmer than the others.

To solve this situation, a suitable resistor is recommended to put in series with each LED circuit. The resistor will limit and balance the driving current which flows through every parallel circuits.

1: 电路设计

由于 LED 的正向电压随温度和驱动电流的变化而变化，在 LED 电路设计中应考虑限制电流保护电路的设计。

LED 作为并联电路时，LED 固有电阻的不同会引起不平衡电流。每一并联电路中存在的平衡驱动电流可能使驱动电源处于不同的功率状态。因此，高功率驱动的 LED 可能受到过驱动电流的破坏，低功率驱动的 LED 可能比其他 LED 更亮。

针对这种情况，推荐一种合适的电阻与每个 LED 电路串联。电阻将限制和平衡流经每个并联电路的驱动电流。

2: Electric Static Discharge (ESD) Protection



All kinds of LED materials, such as GaP, AlGaAs, AlInGaP, GaN, or InGaN chips, are STATIC SENSITIVE device. ESD protection or surge voltages shall be considered and taken care in the initial design stage, and whole production process.

The following protection is recommended:

- (1) A wrist band or an anti-electrostatic glove shall be used when handling the LEDs
- (2) All devices, equipment and machinery must be properly grounded

If LED is damaged by ESD or surge voltage, damaged LED may show some unusual characteristics. It may appear leakage current, and LED does not emit at low current.

And when using microscope to inspect damaged LED chip at low driving current, it may have some black dots within the emitting area.

2: 静电放电 (ESD) 保护

各种 LED 材料, 如 GaP, AlGaAs, AlInGaP, GaN, InGaN 芯片, 是静电敏感器件。静电放电保护或浪涌电压应在初始设计阶段和整个生产过程中加以考虑和采取措施。

建议采取以下防护措施:

- (1) 在处理 LED 时应使用手环或防静电手套
- (2) 所有装置、设备和机器必须接地。

如果 LED 被静电放电或浪涌电压损坏, 损坏的 LED 可能会显示一些不寻常的特性。它可能出现漏电, 并且 LED 在低电流时不会发光的。

低驱动电流时, 当用显微镜检查受损 LED 芯片, 可能会在发光区域内有一些黑点。

3: Pick and Place

The following items should be paid attention in assembly process:

- (1) It should be avoided to load stress on the resin during pick and place process, especially at high temperature.
- (2) Avoid rubbing or scraping the resin by any object, and avoid leaving fingerprints on the lens.
- (3) Electric-static may cause damage to the component. Please confirm that the equipment is grounding well.

3: 拾起和放置

装配过程中应注意以下事项:

- (1) 在拾起和放置过程中, 特别是在高温下, 应避免在胶体上施加重力。
- (2) 避免任何物体摩擦或刮伤胶体, 避免在胶体上留下指纹。
- (3) 静电可能会对 LED 造成损坏。请确认该设备接地良好。

4: Storage

It's recommended to store the products in the following conditions:

- (1) Shelf life in sealed bag: 3 months at $T_A < 40^\circ\text{C}$ and Hum. $< 30\%RH$. (Base on aluminum laminated moisture barrier bag.)
- (2) After the package bag is opened and kept in the following environment, the LED products should be used completely as soon as possible:

Humidity (Hum.): 60%RH Max.

Temperature (T_A): $5^\circ\text{C} \sim 30^\circ\text{C}$ ($41^\circ\text{F} \sim 86^\circ\text{F}$)

Assembly duration: within 12 hours, after bag is opened.

If the some of LED are not used, they need to be kept at Hum. $\leq 10\%RH$ in zip-locked sealed bags. And if the

duration exceeds 12 hours, re-baking process is required to keep LED from moisture.

Please avoid rapid transitions in ambient temperature, especially in high humidity environment where condensation can occur.

4: 储存

建议在下列条件下储存产品:

- (1) 在密封袋内保质期:在温度 $< 40^{\circ}\text{C}$ 及湿度 $< 30\% \text{ RH}$ 的条件下, 3个月。(铝制层压防潮袋。)
- (2) 包装袋打开后, 在以下环境下, 应尽快使用 LED 产品: 湿度: $>60\% \text{RH}$ 温度: $5^{\circ}\text{C} \sim 30^{\circ}\text{C}$ ($41^{\circ}\text{F} \sim 86^{\circ}\text{F}$)
装配时间: 打开包后, 在 12 小时内使用完。

如果有 LED 没有使用, 则需要保存在有密封链的密封袋中, 湿度 $\leq 10\% \text{RH}$ 。

如果使用时间超过 12 小时, 则需要重新烘烤。

请避免快速移动, 特别是在高湿度环境下, 会发生凝结。

5: Cleaning

An alcohol-based solvent such as isopropyl alcohol (IPA) is recommended to clean the LED, after soldering process, if cleaning is necessary. Before cleaning, a pre-test should be done to confirm whether any damage to the LEDs will occur.

It is not recommended to use unspecified chemical liquids as cleaning material for cleaning the LED. It's also not recommended to use ultrasonic power to clean the LED device. The chemical and ultrasonic power could harm the LED devices.

5: 清洁

在焊接过程中, 如果需要清洁, 建议使用醇基溶剂, 如异丙醇 (IPA) 清洗 LED。在清洗之前, 应该做一个预先测试, 以确定是否会对 LED 造成损坏。

不建议使用不明的化学液体作为清洗材料。也不建议使用超声波电源清洗 LED。这种化学和超声波的力量会对 LED 造成伤害。

6: Manual Soldering and Rework

The manual soldering process is not recommended for quality consideration. When it is absolutely necessary, the LEDs may be mounted in this fashion but the user will assume responsibility for any problems.

The the following conditions are recommended :

- (1) Soldering material : SN60 (60% tin and 40% lead) solder or solder with silver content is recommended.
- (2) Temperature of the iron : lower than 300°C

(3) Soldering time : maximum 3 seconds

(4) Operation cautions:

- Please avoid overheating of LED component in any process. Overheating may damage the LED package.
- Please don't place any stress on the lens of LED, especially at high temperature

6: 手动焊接和返工

对于质量考虑, 不推荐手工焊接。当绝对必要时, LED 可以手工焊接, 但焊接方将承担任何问题的责任。

建议以下条件:

- (1) 焊接材料: 建议采用 SN60 (60%锡, 40%铅) 焊锡或使用银焊料。
- (2) 焊铁的温度: 低于 300° C
- (3) 焊接时间: 最高 3 秒
- (4) 操作注意事项:
 - 请在任何过程中避免 LED 过热。
 - 过热可能会损坏 LED 的封装。
 - 请不要把任何重力放在 LED 透镜上, 尤其是在高温的时候

7: Application

- (1) The strong light from LEDs may injure human eyes. Precautions should be taken to prevent looking directly at the LEDs with unaided eyes.
- (2) In order to get maximum light output during the duration of LED's long life, designer should consider how to make excellent thermal dissipation when making the whole system design. It's recommended to avoid intense heat generation and to operate within the maximum ratings given in this approval sheets.
- (3) Every piece of LED will be sorted and LEDs with the same binning grade will be taped into the same reel or put into the same bag. It is recommended to use the same bin-grade LED to assembly the unit module. This will ensure the LED unit module with good uniformity of brightness, hue, and so on.

7: 应用

- (1) led 强光可能会伤害人眼。应采取预防措施, 以防止眼睛直视发光二极管。
- (2) 在 LED 正常寿命内, 为了获得最大的光能输出, 设计者应考虑如何在整个系统的设计过程中进行良好的散热。建议避免高温产生, 并在本规格书内的最大额定值内操作。
- (3) 每个 LED 灯珠都将被分类, 相同 BIN 号的 LED 灯珠将被放在同一个卷盘里或放在同一个袋子里。建议使用相同 BIN 号的 LED 来装配单个成品。这将确保 LED 单个成品颜色, 亮度的一致性。